

Emile Adjibadé Sanya, Houénou Kowanou &
Dèfodji Adolphe Tchéhouali

Valorisation of waste plastic bags in cement-mortar composites as coating of local sand aggregates: Physicomechanical characterisation and potential uses

Peer reviewed and revised September 2015

Abstract

Increasingly high quantities of waste plastics cause major environmental problems in Benin due both to the non-biodegradability of such by-products of the petroleum industry and to a lack of appropriate means of treatment. An option to valorise waste plastic bags is to use these in construction processes. This article studies the incorporation of waste plastic bags into cement-mortar with the aim of reducing proliferation. It explores the immediate consequences of cement-mortar-plastic combinations, such as changes in the resultant composite's water absorption ratio and mechanical properties. The process of making the composite includes some main steps, during which waste plastic bags are first melted at 200°C-250°C and then mixed with sand aggregates. These coated aggregates are then mixed with cement and water into mortar. Moulded specimens of derived composites are then submitted to hydrothermal ripening and mechanical analysis. Experimental results allow optimizing the sand-aggregates coating process, providing data to locate the most appropriate ratio of plastic bags to be between 8% and 12% (wt/wt.mix):theoretically 10.07%. The adopted practical value was 10%, leading to cement-plastic-mortar composites with 90% reduction of water absorption ratio and 11.60% decrease in absolute density, compared to uncoated sand composites. Similarly, the mechanical strengths of composites were 8.83 ± 0.34 MPa in compression and

Dr. Emile Adjibadé Sanya (corresponding author), Energetic & Industrial Engineering Processes, Department of Mechanical and Energetic Engineering (GME), Laboratory of Applied Energetic and Mechanic (LEMA), Polytechnic School of Abomey-Calavi (EPAC), University of Abomey-Calavi (UAC), Republic of Benin, 01 POB: 2009 Cotonou. Phone: +229 98271804, Email: <easanyas@gmail.com>

Dr. Houénou Kowanou, Department of Civil Engineering (GC), Laboratory of Applied Energetic and Mechanic (LEMA), Polytechnic School of Abomey-Calavi (EPAC), University of Abomey-Calavi (UAC), Republic of Benin, 01 POB: 2009 Cotonou. Phone: +229 95964509/64639090 – Email: <hkowanou@yahoo.fr>

Dr. Dèfodji Adolphe Tchéhouali, Department of Civil Engineering (GC), Laboratory of Applied Energetic and Mechanic (LEMA), Polytechnic School of Abomey-Calavi (EPAC), University of Abomey-Calavi (UAC), Republic of Benin, 01 POB: 2009 Cotonou. Phone: +229 96609769, Email: <tchehoua@yahoo.fr>

4.1±0.82MPa in 3-points flexural bending, corresponding to 74.1% and 48.1% weakening, respectively. These resistances were judged to be weak, with the result that the composites thus obtained cannot be used as the main elements of structural constructions. Potential applications are water-sealing/repellent materials in walls/soil, ending with good values of a wear-resistance index similar to commercial quarry tiles/stoneware.

Keywords: Waste plastic bags, cement-plastic-mortar composite, aggregates coating, ripening, water-absorption ratio, wear-resistance index

Abstrak

Hoë hoeveelhede afvalplastiek veroorsaak toenemend groot probleme in die omgewing van Benin as gevolg van beide die nie-afbreekbaarheid van sodanige by-produkte van die petroleum-industrie asook 'n gebrek aan 'n geskikte middel om dit te behandel. 'n Opsie om afvalplastieksakke te valoriseer is om dit in konstruksieprosesse te gebruik. Hierdie artikel ondersoek die invoeging van afvalplastieksakke in sement-klei met die doel om die verspreiding daarvan te verminder. Dit ondersoek die onmiddellike gevolge van sement-klei-plastiek kombinasies, soos veranderinge in waterabsorpsie-verhouding, asook die gevolglike saamgestelde en meganiese eienskappe daarvan. Die proses om die samestellings te maak behels 'n paar belangrikste stappe, waartydens afvalplastieksakke eerstens gesmelt word by 200 °C - 250 °C en dan gemeng word met sand-aggregate. Hierdie bedekte aggregate word dan gemeng met sement en water tot 'n klei. Gevormde monsters van afgeleide samestellings word dan voorgelê vir hidrotermale rypwording en meganiese analise. Eksperimentele resultate laat optimalisering van die sand-aggregate bedekkingsproses toe, deur data te verskaf om die mees geskikte verhouding van plastieksakke op te spoor wat tussen 8% en 12% (wt / wt.mix): 10.07% teoreties behoort te wees. Die aanvaarde praktiese waarde was 10%, wat gelei het tot sement-plastiek-klei samestellings met 90% vermindering van waterabsorpsie-verhouding en 11,60% afname in absolute digtheid, in vergelyking met onbedekte sand samestellings. Net so, was die meganiese sterkte van die samestellings $8,83 \pm 0,34$ MPa in kompressie en $4,1 \pm 0,82$ MPa in 3-punte buig buiging, wat ooreenstem met 74,1% en 48,1% verswakking, onderskeidelik. Hierdie weerstand is swak, met die gevolg dat die samestellings nie gebruik kan word as die belangrikste elemente van strukturele konstruksies nie. Potensiële toepassings daarvan is water-verseëling/afweermiddel materiaal in mure/grond, met goeie waardes van 'n dra-weerstand indeks soortgelyk aan kommersiële kleiteëls stoneware.

Slutelwoorde: Afval plastieksakke, sement-plastiek-klei samestelling, aggregate bedekking, rypwording, waterabsorpsie-verhouding, slyt-weerstand indeks

Abbreviations:

CNERTP: National Centre for Essays and Research in Public Works

CREPA: Centre Africain pour l'Eau Potable et l'Assainissement

GTZ: Gesellschaft für Technische Zusammenarbeit

INSAE: National Institute for Statistics and Economical Analysis

LDPE: Low Density Polyethylene;

M, MS: Mass, Mass of sand aggregates

MEHU: Ministry of Environment and Urban Buildings of Benin

MPa: Mega Pascal (Resistance/strength unity)

RGPH: Population's General Census and Housing

RH: Relative Humidity (%)

RNCN: National Network of Resources Centre

SCB-Lafarge: Lafarge Cement Company or Society of Benin

WPB: Waste Plastic Bags

WRI: Wear-Resistance Index

1. Introduction

The rapid global increase in urbanisation, especially in Africa and mainly in Benin (INSAE, 2013: 1-8, Vissoh, 2012: 1-313, RNCN, 2011: 1-59; Word-Bank, 2010: 1-87), leads to enormous volumes of refuse, including non-biodegradable materials such as plastics (Ad  gbindin, 2009: 1-80, Codjia, 2009: 1-74, GTZ & MEHU, 1998: 1-27; Gb  do, 2009: 1-237, INSAE, 2013: 1-8; Vissoh, 2012: 1-313). According to Benin projections for 2012, landfills have effectively increased by 12,000 tons of plastic waste, including over 50% of plastic bags. Recycling is thus indispensable as the only way to save the environment from risks associated with plastic wastes (Lawson, Liady & Boglo, 2008: 1-63; RNCN, 2011: 1-59; Codjia, 2009: 1-74; GTZ & MEHU, 1998: 1-27; Gb  do, 2009: 1-237). However, all supposedly recycled plastic wastes in Benin still fall in the non-recycled category, as adopted modes make for early recycling (Codjia, 2009: 1-74; Gb  do, 2009: 1-239; GTZ & MEHU, 1998: 1-27). According to a report from the National Network of Resource Centre (RNCN, 2011: 1-59), 86% of plastic bags are simply thrown into the streets after use; 5.50% incinerated outdoors; 5.50% used for cooking in kitchens and the remaining 2.75% are kept for various other usages.

Recycling plastic bags, using modern techniques, is one of the vital ways in which the people of Benin and other sub-Saharan countries can ensure a healthy environment. Unfortunately, in the majority of countries, technical and financial resources for basic recycling are virtually non-existent (Codjia, 2009: 1-74; Gb  do, 2009: 1-239; GTZ & MEHU, 1998: 1-27). In this context, the infrastructure constructions sector is a large potential consumer and a good consignee of waste plastics. Scientific literature mentions that the topic is real and indicates that

there are many opportunities for recycling waste plastics, including plastic bags, for construction processes (Afroz-Sultana & Prasad, 2012: 1185-1191; Ghernouti & Rabehi, 2009: 93-100; Moatasim, Cheng & Al-Hadidy, 2011: 2764-2770, Yazoghli-Marzouk, Dheilly & Queneudec, 2005: CD-ROM). The waste plastic bags have been incorporated into mortars and classic concretes for constructions and into bituminous concretes for roads (Afroz-Sultana & Prasad, 2012: 1185-1191; Jain, Kumar & Sengupta, 2011: 233-238; Prasad, Prasada-Raju & Kumar, 2009: 1-12; Yazoghli-Marzouk *et al.*, 2005: CD-ROM; Vasudevan *et al.*, 2007: 105-111). Some authors pointed out a reduction in the mechanical strength of such concretes as the percentage of plastic wastes increased, but the composites remained sufficiently resistant and performed well hydraulically (Yazoghli-Marzouk *et al.*, 2005: CD-ROM; Vasudevan *et al.*, 2007: 105-111). By contrast, the method has had a beneficial effect in reducing mortars decay in an aggressive environment (Ghernouti & Rabehi, 2009: 93-100). Indeed, a decrease in mortars mass loss was observed when it was kept in a sulphuric acid solution. This improved progressively as the incorporated ratio of waste plastics increased. Plastic inclusion greatly reduced chlorite ions penetration into mortars and concretes (Ghernouti & Rabehi, 2009: 93-100). Furthermore, researchers highlighted the potential use of waste plastics and tyres in the surface layer of roadways (Vasudevan *et al.*, 2007: 105-111; Yazoghli-Marzouk *et al.*, 2005: 1-8). Plastic wastes, cut into 2.36mm to 4.75mm particles, heated to about 170°C, stirred for thirty minutes and added to graded 80/100 bitumen, resulted in a decrease in penetrability and ductility values. By contrast, an increase in softening, flash and fire points, and Marshall's stability, respectively, recorded an improvement in adhesiveness (Vasudevan *et al.*, 2007: 105-111). Nevertheless, this method has limitations. When waste plastic bags are incorporated into bitumen, at a weight content exceeding 2%, material segregation can occur at the cooling stage. This limitation led the authors to develop alternative methods: the use of waste plastics for flexible pavements (Vasudevan *et al.*, 2007: 105-111), allowing for greater use of waste plastics. A number of authors have worked in this field (Vasudevan *et al.*, 2007: 105-111; Afroz-Sultana & Prasad, 2012: 1185-1191; Al-Hadidy & Tan, 2009: 1456-1464; Prasad *et al.*, 2009: 1-12; Garcia-Morales *et al.*, 2012: 936-943; Gupta & Veeraragavan, 2009: 55-64). One of the methods includes heating the aggregates to about 170°C and introducing plastics cut into 2.36 mm to 4.75 mm particles. Softened plastic waste, mixed with 60/70 or 80/100 graded bitumen, was used to shell aggregates grains also previously heated to 160°C in pavement. The resulting binders exhibited improved characteristics such as best adhesiveness, higher

softening point, better penetrability and increased resistance against water penetration (Vasudevan *et al.*, 2007: 105-111).

The above shows that there are solutions to problems in managing waste plastics. However, the proposed techniques can still be improved, not only for a better valorisation of waste plastics (waste plastic bags, in particular) in infrastructural constructions, but also for a quantitative broader use. This article is devoted to better mastering the waste plastic bags inclusion process into the construction of buildings, particularly in cement-mortar-plastic composites made of local coated sand aggregates using molten waste plastic bags in a range of 2% to 18% (wt/wt.mix). This article explores the induced effects on the water absorption ratio and the mechanical properties of derived cement-plastic-mortar composites with regard to added plastic percentages and specimen's age. Specifically, the performance characteristics of the manufactured specimens of blended cement-mortars using molten waste plastic bags, at optimized coating ratio of 10% (wt/wt.mix), providing the best composite material, were analysed with regard to their potential uses.

2. Materials and methods

2.1 Materials

The main raw material of interest in this study is waste plastic bags.

2.1.1 Waste plastic bags

These plastic bags are collected from landfills with the aim of cleaning up the living environment. Once collected, waste plastic bags are properly cleaned with soapy water, then rinsed with water and dried in the sun. Only black waste plastic bags are used. These consist chiefly of materials made of low-density polyethylene (LDPE) that belongs to linear or branched chains of the thermoplastic polymers class obtained from additive reactions, often represented as $(-CH_2-CH_2-)_n$. The LDPE's overall behaviour thus depends on the chains' mobility relative to each other and on C-C bonds rotation. When heated (thermoplastics), LDPE melts/softens, but recovers its rigidity on cooling; this mechanism is reversible. This main property of LDPE was thoroughly exploited in the current study.

2.1.2 Aggregates

The two types of aggregates used are sands, with the knowledge that sand is cement-mortar's major adulterant (Neville, 2000: 463-513; Maso, 1982: 247-259; Pumia *et al.*, 2003: 134-140; Wood, 1991: 630-643). The one type of aggregate, taken control, is normalised sand, according to CEN-EN196-1 standards, and represented in this investigation by S₁; the other type is rolled sand aggregates S₂ originating from "Adjohoun" in Ouémé-Plateau, a south-eastern Department of Benin Republic. It has an equivalent-of-sand value of 91%, bulk density of 1.54, absolute density of 2.64g/cm³, a fineness modulus (M_f) of 2.71, and the structure of particles size distribution as shown in Figure 1.

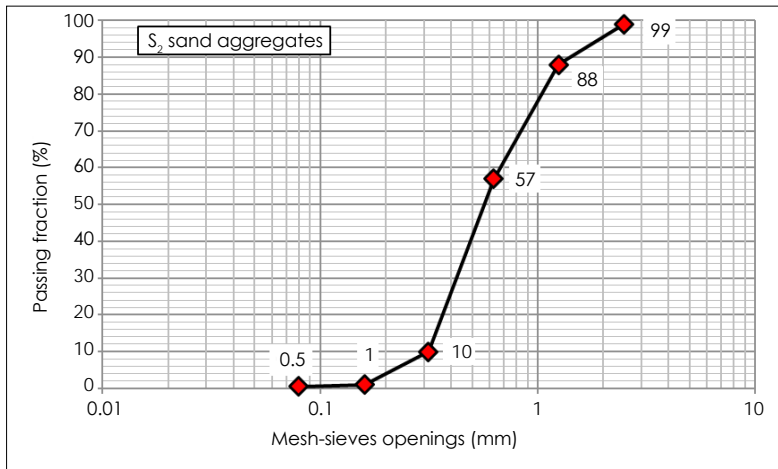

Figure 1: Used sand aggregates S₂ particles size distribution

2.1.3 Cement

The cement used is from Brand Shield Bouclier CPJ-35, provided by Lafarge Cement Company of Benin, called "SCB-Lafarge". Table 1 indicates its chemical composition and essential characteristics.

Table 1: Chemical composition of Bouclier cement CPJ-35¹ from SCB-Lafarge and some physical properties (hardening time, specific area, specific weight)

Components	SiO ₂	Al ₂ O ₃	Fe ₂ O ₃	C _a O	M _g O	K ₂ O	N _a O	SO ₃	Free-C _a O
%	16.84	4.0	3.08	59.82	1.67	0.34	0.0	2.51	1.08
Specific weight: 3.092 (g/cm ³); Bulk density: 0.992 (g/cm ³); Specific area: 3,665 (cm ² /g)									
Initial setting time ² :174;			Setting time ² : 68;			End setting time ² : 242.			
¹ Product from Onigbolo Cement Factory (Pob��): 16 July 2012									
² Time in minutes									

2.2 Experimental equipment and accessories

The experimental equipment used includes, among others, a metallic container, a gas stove, an electric mixer, an electronic Mettler laboratory scale (scale range 4,000g, sensitive tenth gram), a range of moulds (40x40x160mm) for cement-mortar specimens, a set series of standardised AFNOR sieves, a mortar/concrete vibrator shock-apparatus, a beaker, a stem thermometer (with a range of 0  C-400  C), K-type thermocouples, an oven-dryer (of 250  C capacity), an air-conditioned room (at 18  C), a large water bath for immersing specimens during sample maturation, and a stopwatch.

2.3 Methodology

2.3.1 Fundamentals of the viewed concept

As is known, at the end of the hydraulic concrete moulding, aggregates are surrounded by a transition layer of a few tens microns area, called feeble loose zone, and composed of two rings or layers (Maso, 1982: 247-259). Maso indicated that the first layer, in contact with granulate, is very compact and very fine textured, and closely attached to the aggregate by physical bonds and perhaps also chemical bonds, except for derived mica minerals, for which no connection is established. The second layer contains large-dimension, highly porous crystals, preferred orientation and low cohesion. Given the characteristics of this halo transition, the second layer is the site of first irreversibility and, in particular, the seat of porosity. In a cement concrete subjected to strength in compression or traction (Figure 2.1), stresses are more intense (isostatic stresses concentration) around skeleton (non-deformable granulate/aggregate in centre) than cement paste matrix.

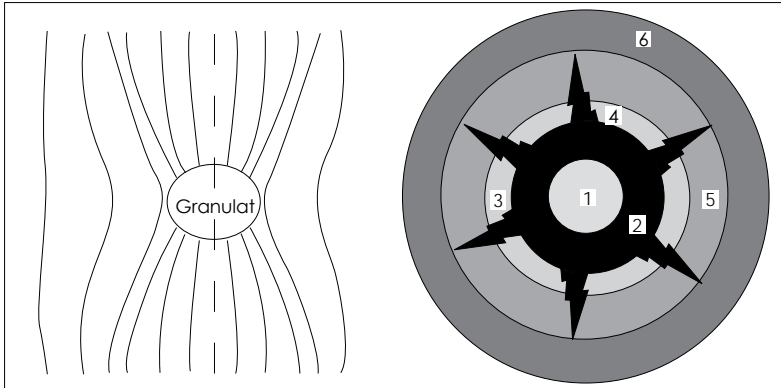

Figure 2: Paste-aggregate bonding model in cement concrete (Figure 2.1, at left) (Maso, 1982: 247-259) and schematic model of pursued concept (Figure 2.2, at right)

The pursued main objective in sand granulates coating is to clog the opened internal pores in cement-mortar with generated growths from molten plastic bags, essentially at the ripening stage. This objective of the current process is conceived and defined for achieving the following goals:

- To cover sand aggregates (1) with a coat made of a layer of melted waste plastic bags (2);
- To manufacture cement-mortar specimens, using the previously coated sand aggregates, and
- To submit specimens of the derived cement-mortars to ripening thermal treatment.

The ripening consists of subjecting these cement-mortar specimens to the process described in Figure 3, after the specimens have been demoulded, their moulding having been accomplished 24 hours earlier. Depending on the targeted age in the study, cement-mortar specimens of 2 days should be extracted from immersing water 24 hours later; the ones of 7 days, 6 days later, and those of 28 days, 27 days later, and so on. Mortar specimens are then weighed prior to being introduced in the oven at 105°C for 72 hours. After that the specimens are weighed again and soaked in water for 72 hours, whereupon they are returned to the oven for another 72 hours. A new water-immersing stage follows, for the same duration, whereupon they are again returned to the oven at 150°C for 72 hours. Each of these three steps of thermal ripening in the oven are interspersed with cold water-immersion steps effected at $21 \pm 1^\circ\text{C}$ for 72 hours. The

described curing treatment is conducted on 2-day, 7-day and 28-day composite mortar specimens, respectively. In applying hydrothermal maturing treatment at different stages, the aim is that the supplied heat acts by inducing generation of a few growths (3), as shown in Figure 2.2, from enveloping plastic bags layer (2), which previously coats aggregate granulate (1). These growths subsequently clog the opened cracks in the halo of transition, in the first layer (4), and especially the pores in the second layer (5), more porous ones in cement paste (6), as indicated in Figure 2.2.

2.3.2. Aggregates' coating procedure

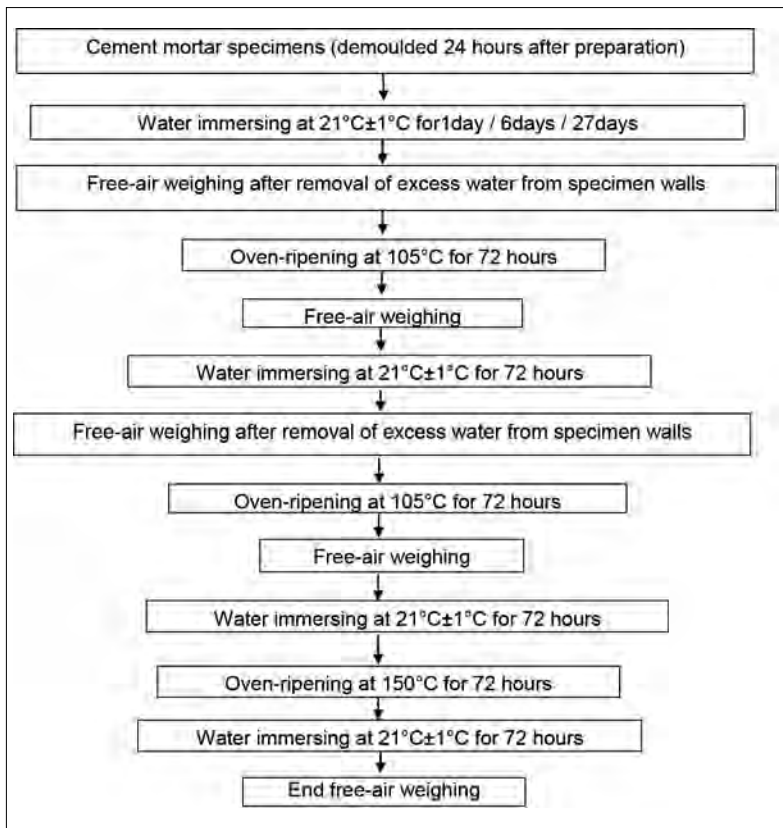

Figure 3: Flowchart of applied hydrothermal ripening to plastic-cement-mortar specimens

The sand-aggregates coating process takes place as follows:

- Black waste plastic bags collected from landfills are pre-treated with soapy water, followed by rinsing with water and drying in the sun.
- The cleaned and dried waste plastic bags are then weighed (mass MD) and heated to fuse in an appropriate metallic container on a gas stove. This melting process is methodically carried out with an operative temperature monitoring of between 200°C and 270°C (maximum). For this, TESTO temperature recorder type 0°C-1000°C, 4-outputs, equipped with K-type thermocouples, was used cautiously. It is well known that polyethylene ignition temperature and in particular, decomposition temperature, such as those for most plastic materials, are between 300°C and 350°C (Vasudevan *et al.*, 2007: 105-111; Behjat *et al.*, 2014: 795-802). Figure 4 shows an example of the acquired typical kinetics in terms of temperature during the plastic-melting phase combined with the cooling phase, due to the introduction of sand aggregates during direct-coating operation cycles. In the melting phase, waste plastic bags display three typical transformation steps, known as fusing material behaviour. In fact, in the present investigation, used waste plastic bags belonged to the all-comers category. The bags became completely liquid in all of the practical tests at a temperature of between 200°C and 260°C, as shown in Figure 4.

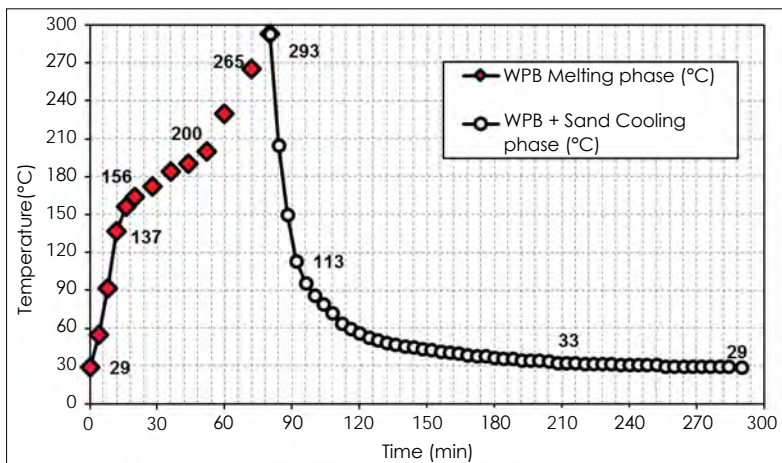

Figure 4: Recorded temperature in waste plastic bags (WPB) melting phase coupled with sand aggregates-melted plastic mix (WPB + Sand) cooling phase during the coating process

- The previously weighed (mass M_s) sand aggregates are then poured into the molten plastic bags (mass M_{WPB}) and the mixture ($M_s + M_{WPB}$) is continuously stirred. The metallic container is kept on the gas stove in order to maintain the heat, until a homogeneous mixture in colour and consistency is reached.

The resulting mixture, S_2 -sand aggregates + plastic bags ($S_2 + WPB$), is stirred continuously in order to avoid caking caused by fast cooling. Indeed, preliminary tests showed that this can lead to the formation of pancakes. In laboratory testing, for about 1kg of mixture, a rotating electromechanical agitator was used as mixer at a relatively low speed of 55-60rpm. For larger quantities, a higher electromechanical mixer or combined plastic melting-stirrer device is needed. Otherwise, a 10-litre metallic recipient and a wooden bar for stirring can be manually operated to achieve the final mixture on a large size steel sheet.

The added binder ratio (C_{WPB}) was calculated as percentage mass ratio of molten waste plastic bags (M_{WPB}) to that of mixture (M_{S+MWPB}), according to relationship (1):

$$C_{WPB} = 100 \cdot M_{WPB} / (M_s + M_{WPB}) (g_{WPB} / 100g_{S+WPB}) \quad (1)$$

At this stage of the process, the coating material (molten waste plastic bags) is improperly called "binder", because it acts like aggregates, as cement remains, in fact, the main binding constituent of composite mortar.

- To complete the coating procedure, the resultant coated sand aggregates are passed through 5mm opening mesh-sieve to ensure not only looseness, but also uniform granularity. It is known that large-sized particles always cause stress concentration around particles of sand aggregates, which has a major effect in lower strengthened concretes (Maso, 1982: 247-259; Dorlot *et al.*, 1986: 1-467; Xie-Ping *et al.*, 1991: 999-1005). The different tested percentages of molten plastic bags (CPB) mixed with sand aggregates, for achieving various coating trials, were 2%, 5%, 8%, 10%, 12%, 15% and 18% (plastic bags weight to mix weight), respectively. Higher percentages have been successfully found in roads pavement studies.

2.3.3 Cement-mortar composite specimen's preparation

Specimens subjected to various tests were prepared, using the requirements of NF-EN196-1 standards for the so-called "normal" cement-mortar: 1,350g of aggregates, 450g of cement and 225g of water per mixture or batch. A vibrating shock machine was used for the best homogenisation of mortar moulding. The mortar specimens, 40mmx40mmx160mm, were manufactured using three (3) sand variants: normalised sand, uncoated sand aggregates₂ (as control), and coated sand aggregates₂ with molten plastic bags at the previously mentioned percentages. After preparation, the specimens were subjected to heat-curing treatment. This is designed not only for cement-mortars maturation, but also for inducing deformation of deposited molten plastic bags layer in the coating process and for subsequently initiating growths development towards porous vulnerable sites within the crown or halo of transition: in the first layer 4, and in the second layer 5, (Figure 2.2).

2.3.4 Water absorption ratio measurements

As is known, concrete porous volume, regardless of the ease with which a fluid can pass through, is measured by the water absorption ratio. These two concepts are not necessarily linked, according to Maso's (1982: 247-259) granulate-cement paste bonding study. The absorption rate is usually measured by means of a procedure consisting of concrete specimen drying to constant mass, water-immersing it and finally measuring mass increase expressed in dry mass percentage (ASTM-C1403). In this study, the adopted procedure complies with one of seven cited and described methods in Neville (2000: 463-513). The procedure consists of immersing the cement-mortar specimen in water for 72 hours, removing it, eliminating excess water at specimen walls using absorbent paper, and free-air weighing prior to oven-drying at 105°C for 72 hours, whereupon the specimen is finally free-air weighed by means of the buoyancy method in distilled water. The water absorption ratio of the studied cement-mortar specimens was measured principally at the 2-day, 7-day and 28-day ages, respectively. Before the required age expires, the cement-mortar specimens are preserved in cold water in a climatic chamber maintained at 18°C±1°C. Once the water absorption test starts, the immersion water is kept at a temperature of 21°C±1°C, according to the requirements of ASTM C642-90 standards which prescribe 21°C. The on-site recorded average relative humidity, at that time, is RH=70±5%. Measurements are performed on three specimens per each lot (2 days, 7 days and 28 days). Then, the data per age are mean-values of three results. These obtained values for the water

absorption ratio were subsequently compared with cement-mortars that are manufactured using the well-known Sikalite.

2.3.5 Absolute density determination for cement-mortar composites

In these test series dedicated to the analysis of specimens' absolute density evolution over time, mean values from triplicate measurements at 2-days and 28-days were also adopted. The procedure followed, in absolute density measurements, is the so-called "floatable" or "buoyancy" weighing method. It consists of taking specimen weight at dry-state on free-air using a Mettler laboratory balance before water-immersing it for at least 72 hours for saturation. Thereafter, the concrete specimen is removed from the water bath and excess water eliminated at specimen surface using absorbent paper. It is then free-air weighed, on the one hand, and in distilled water in buoyancy state, on the other.

2.3.6 Optimisation of waste plastic bags coating process

Taking into account the behaviour of the data obtained, following water absorption test results from composite specimens made of coated aggregates using melted plastic bags percentages of 2%, 5%, 8%, 12%, 15% to 18%, respectively, the theoretical optimisation study of the coating ratio was effected. This allows isolating the optimised value of waste plastic bags content: 10% (wt/wt.mix). Cement-mortar-plastic composite specimens were then manufactured at coating, retaining the optimal ratio (10%) at which physical mechanical properties were specifically studied. For this purpose, in making these tested composite specimens, the initial water and cement quantities (dosages) were also multiplied, first by factor 1.5 and then by factor 2.0. A comparison was made on the basis of decoulant mechanical characteristics.

2.3.7 Assessment of the composite's mechanical resistance

Specimens of three (3) variants of cement-mortar-plastic composite were mechanically tested. They include prepared variant specimens, using normalised standard sand; prepared variant specimens, using uncoated sand aggregates S_2 as controls, and prepared variant specimens, using coated sand aggregates S_2 at identified waste plastic bags' optimized ratio of 10% (wt/wt.mix). The applied mechanical tests comprise 3-points flexural bending and simple axial compression with respect to three finally used variants of sand aggregates and derived mortars specimens' ages:

- 2-days, 7-days and 28-days for composite specimens made of normalised standard sand aggregates;
- 2-days, 7-days and 28-days for prepared specimens from uncoated sand aggregates S_2 ;
- 2-days, 7-days, 14-days, 28-days, 45-days and 90-days for specimens made of coated sand aggregates S_2 with melted waste plastic bags; the last two ages (45days and 90days) correspond to trials conducted for simulation of the composite's long-term behaviour study.

2.3.8 Potential use of cement-mortar-plastic composites

Technical performances were compared in the search for potential uses of the cement-mortar-plastic composite. In this study, the cement-mortar-plastic composite was made for the manufacture of building tiles, particularly those for walls and floors. For the comparative study, specimens of stoneware or quarry tiles (20 different units), faiences/ fine ceramic (20 different units) and locally artisanal tiles (10) were bought from commercial companies at Cotonou. These bought specimens and those from cement-mortar-plastic composite were tested for water absorption ratio, on the one hand, and for surface wearing, on the other. An agreed wear-testing apparatus of the HELLEMMS MPR type, operating at a constant speed of exactly 75 rotations, accompanied by a $150\text{mm} \pm 0.01\text{mm}$ digital calliper (Facom) for wear depth/impact measurement, were used. Such conditions are normally used in commercial quarry tiles and stoneware testing by the National Centre for Essays and Research in Public Works (CNERTP), a unique laboratory in this field in the Benin Republic. The measured wear depth L (mm) by the wear-testing machine allows for assessing the wear-resistance index value (WRI) of a tested material in reading established curves net or table based on the requirements of the NF-EN-ISO-4288 standards. However, WRI-value can also be calculated, using the following formula (2), expressing a proportionality of work done to the snatched material volume (V):

$$\text{WRI} = (\pi \cdot d \cdot N \cdot F) / V \quad (2)$$

where d is diameter of steel disc ($d=200\text{ mm}$), N number of cycles ($N=75$ rotations), F applied force value ($F=2.0\text{ kgf} \approx 19.61\text{ N}$). Volume of snatched material (V) is calculated as a product of the disc angular sector area by disc thickness:

$$V = E \cdot \frac{d^2}{8} \left[\frac{\pi}{90} \text{Arccsin} \frac{L}{d} - \sin \left(2 \cdot \text{Arccsin} \left(\frac{L}{d} \right) \right) \right] (\text{mm}^3) \quad (2')$$

It links the thickness of the steel-disc (E), its diameter (d) and measured wear depth L(mm).

3. Results and discussion

The results of the implementation of various formulations of cement-mortar composites described in the protocol, are presented. The behaviours of new mortar composite specimens were analysed, mainly at 2-days, 7-days and 28-daysages. However, the behaviour of cement-mortars, from coated sand aggregates (S_2) using molten plastic bags at optimal ratio of 10%, was analysed over a long period (up to 90 days) especially for investigating the mechanical resistance of this type of cement-mortar composite. In fact, several studies in the field have confirmed that some of the properties of normal cement-concrete can increase in long-term storage conditions (Neville, 2000: 463-513; Pumia *et al.*, 2003: 134-140; Dorlot *et al.*, 1986: 1-467; Larbi, 1993: 1-69). These cement-plastic-mortar composites may also exhibit similar behaviour under long-term storage conditions.

3.1 Aggregates coating process

Mastering the coating process is crucial for the success of this method.

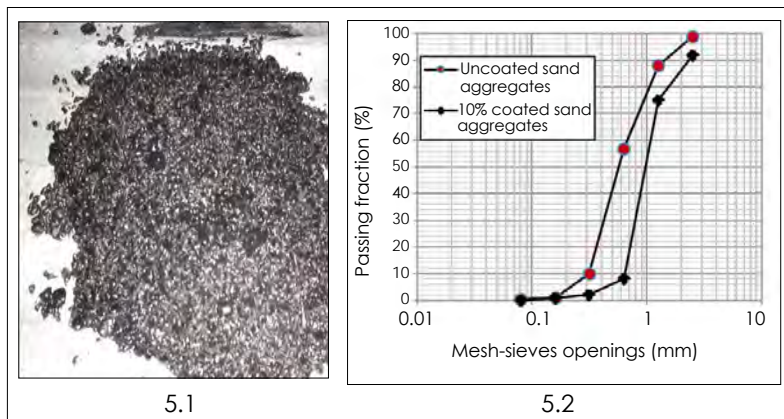

Figure 5: Observed flocs in coating process' first steps, due to sudden drop in temperature following the addition of sand to melted plastic bags

Figure 5 illustrates an example of the results obtained with many flocs from preliminary coating experiments that failed due to fast cooling and taken in mass. These instances of flocculation are due

to a sudden drop in the temperature of the mixture, when sand aggregates were introduced into the molten plastic bags (binder), causing a very rapid cooling phase. Obviously, a kind of early flocculation can occur during these coating phases, showing grass masses resembling those flocs shown in Figure 5. These examples are failed cases of coated sand aggregates. Results in Figure 5 show those obtained taken in mass (5.1) and the kinds of clusters of flocs from the composites. They also justify why the coating process must occur under hot temperature, with the progressive addition of sand and continuous stirring, in order to obtain a completely homogeneous mixture.

The experimental results, in Figures 6.1 to 6.4, show successfully coated sand aggregates. The successful coating process is characterised by independently coated aggregates forming perfectly loose “coated” individual sand granulates. No higher bounded agglomerate from coated sand aggregates exceeding 5mm opening mesh-sieve was obtained when coating procedure succeeded, as shown in Figure 5.2 (results of particles size analysis) and in Figure 6 (coated aggregates physical state on images taken).

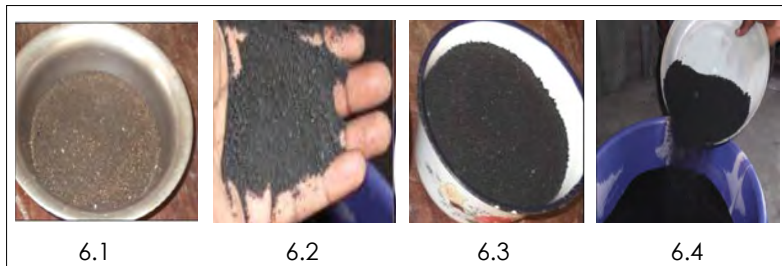

Figure 6: Coated S_2 sands are perfectly loose after successful operations with different appearances: coated sand at 2% (6-1), 5% (6-2), 8% (6-3), and 10% (6-4)

Figure 6 also shows different coloured aspects of coated sand aggregates corresponding to the different waste plastic bags percentages used. In Figure 6.1, the relatively clearer appearance was obtained with 2% melted waste plastic bags coated aggregates. Figures 6.2 and 6.3 disclose two variants of coated sand aggregates using 5% and 8% (wt/wt.mix) melted waste plastic bags, respectively. The darker or black aspect is obtained in the case of 10% waste plastic bags coating application to sand aggregates, as shown in Figure 6.4.

These examples for variants of coated sand aggregates, at the level of sand granules coating steps of devised method, on the one hand, and the results obtained from extensive testing for the purpose, in particular at waste plastic bags incorporated contents from 2% to 18% (wt/wt.mix), on the other, have mainly proved that the planned coating process

- is not only undeniably feasible, but also, at different binder (= molten waste plastic bags) ratios, from 2% to 18%, with obviously the problems associated with each procedure;
- a realized experiment in tested dosages ranging from 2% to 18% (wt/wt.mix) showed a relatively powerful facility for sand aggregates coating, using binder contents between 8% to 12% (wt/wt.mix), compared with coating operations done at higher waste plastic bags concentrations, namely 12 to 18%;
- requires, of all the composites preparation phases, a rigorous control and continuous (rather permanent) stirring of sand granules-fused plastic mixtures. Otherwise, a too rapid cooling of mixtures could occur and cause them to fail and subsequently yield similar products to the ones shown in Figure 5. In the latter, material flocs or agglutinations have been recorded which consequently prevented us from achieving adequate and homogeneous coated sand aggregates.

3.2 Composite mortars manufactured specimens

An effective mastery of different phases of the applied coating process to sand aggregates, on the one hand, and mastery of the manufacturing process of tested mortar specimens, on the other, form various composite specimens (see Figure 7). In Figures 7.1, 7.2, and 7.3 and more clearly in Figures 7.4 and 7.5, some examples of different appearances were obtained as a result of the use of uncoated (pure) sand aggregates S_2 (Figure 7.1) and of coated sand aggregates S_2 , using the molten waste plastic bags at the rate of 15% (wt/wt.mix) (Figure 7.4). These coating-process experiments clearly show that, as the waste plastic bags' percentage incorporated into the cement-mortars increased (from 0% to 18% wt/wt.mix), the more pronounced was the decoulant black colour of the final cement-sand-plastic composite.

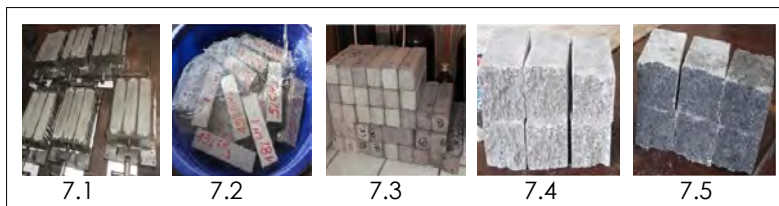

Figure 7: Various specimens' aspects obtained after cement-plastic-mortar moulding, demoulding and ripening

3.3 Measured water absorption ratios

Figure 8 shows the results of the experiments devoted to assessing the water absorption rate of cement-mortar composite specimens made of coated aggregates at different molten waste plastic bags percentages and mortar ages of 2-days, 7-days and 28-days. An analysis of these results identified that, in values ranging between 5% and 18% (wt/wt.mix), sand aggregates coating with melted waste plastic bags might be beneficial for use in cement-mortars in order to counteract water penetration, because of the recorded weak values of water absorption ratios: between 2.6% and 4.8%. Similar values for water absorption ratios have been reviewed and published for cement mortars and concretes (Neville, 2000: 463-643; Wood, 1991: 630-643; Purnia *et al.*, 2003: 134-140), and represent some of the best values in the field of counteracting water penetration. However, according to current research, the best results are obtained for cement-mortar composites made of melted waste plastic bags ratios of between 8% and 12% (wt/wt.mix), with water absorption ratios of less than 2%.

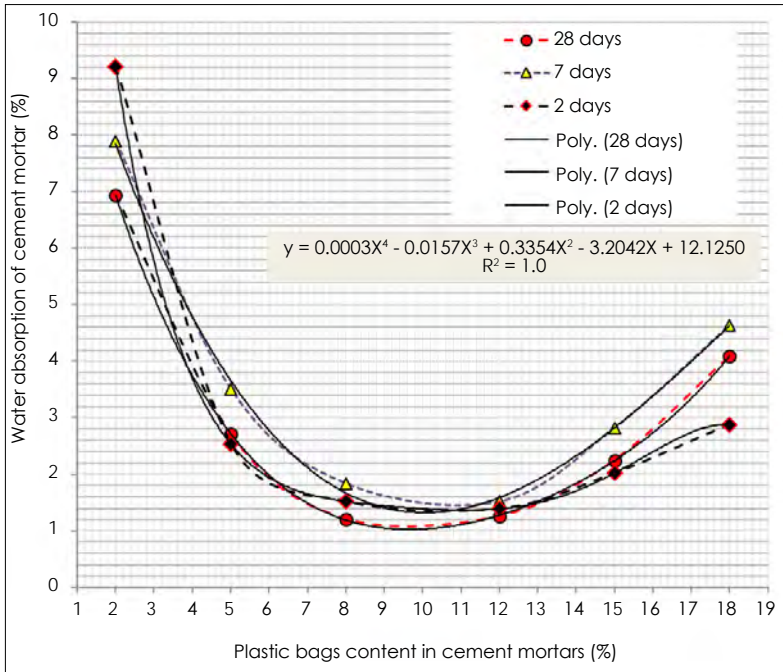

Figure 8: Specimens of water absorption ratios versus incorporated melted waste plastic bags percentages at different cement-mortar composites age

It is interesting to note that, owing to the behaviours of various tested specimens, as shown in Figure 8, one can easily understand and affirm that the sought water absorption ratio's optimal value is obviously located in the last targeted interval of [8%, 12%]. Nevertheless, an optimisation procedure was conducted for assessing the value of the waste plastic bags content, which minimizes the water absorption ratio. In this study, the modelling function corresponding to the equation of tendency (3), that adequately matches 28-days experimental data (the most accurate), has subsequently been chosen and expressed as follows:

$$Y=0.003X^4 - 0.0157X^3 + 0.3354X^2 - 3.2042X + 12.125 \quad (3)$$

with a regression coefficient value of $R^2=1.0$.

Derivation of function (3) leads to the following function (4), which has been set to zero for assessing roots, particularly the real one of the existing three:

$$dY/dX = 0.0012.X^3 - 0.0471.X^2 + 0.6708.X - 3.2042 = 0 \quad (4)$$

Trend equation (4) was then solved using Excel Software 2008. Theoretical calculations led to molten waste plastic bags percentage (X) of X=10.07045%, corresponding to the theoretical minimised water absorption ratio (Y-value) of Y=0.922%, according to selected model equation (3). It was found that the X-value finally justified the choice for the adopted practical X-value of X=10% for waste plastic bags ratio, leading to the corresponding Y-value of Y=0.923% assigned for realising our complementary investigations.

This was also used to find out the reasons why recorded values for water absorption ratio on the tested specimens increased beyond the plastic bags content of about 12% to 18% (wt/wt.mix). Indeed, Table 2 reveals the results of the trend relative to increasing water absorption ratio for the tested composite specimens, using 12% to 18% waste plastic bag contents.

Table 2: Water absorption increase ratios beyond 12% incorporated plastic bags content in cement-plastic-mortar composites

Water absorption ratio(%) at plastic bags contents of		Recorded ratio increase beyond 12% plastic content (%)	Age of tested mortar specimens (in days)
12%	18%		
1.39	2.88	51.74	2
1.52	4.64	67.24	7
1.26	4.10	69.20	28

It is obvious that, in selected interval [12%, 18%] (wt/wt.mix basis) and for tested specimens' different ages (2 days, 7 days and 28 days), the obtained water absorption ratios showed significant relative increases: 51.74% at 2 days, 67.24% at 7 days and 69.2% at 28 days (the percentage increase is based on respective values reached at 18% plastic bags content).

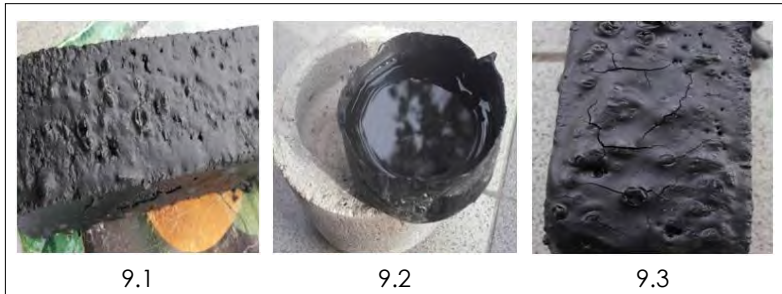

Figure 9: Thin layer coating (9.1), using molten waste plastic bags (no crack) can even be used to take water (9.2); thick layer coating cracks (9.3)

These exploratory tests also revealed that, at the macroscopic level, the coatings thus realised (Figure 9), using molten plastic bags, cracked when deposited thicknesses were larger (Figure 9.3) than for thin coated layers (Figure 9.1). It is thus highly probable that a similar phenomenon occurred at the microscopic level of the coated materials, causing micro-cracks when the layer of melted plastic bags became thicker around aggregate granules. The attempt to interpret this observed behaviour was attributed to the irregular shrinkage of a large mass of molten plastic bags tied to a more intense cooling surface, resulting in a faster curing at the depth of the deposited coating material. During the cooling phase, generated thermo-mechanical stresses tend to induce a curved surface of molten plastic bags layer on the outside. As all material matrix masses reach the same temperature when cooling, internal stresses become higher than external ones. The bonds are also more rigid in the vicinity of aggregates (Maso, 1982: 247-259; Wood, 1991: 630-643), the cement-mortar composite having a rigid body at operating temperature. These higher internal constraints consequently force the material structure to bend inwards, hence generating outer surface expansion, which cannot follow this induced trend. Accordingly, cracks emerge due to the collapse, and grow with material mass cooling rate. These resulting cracks may explain why cement-mortar-plastic composite can turn out and be again vulnerable to water penetration. Water passes through the cracks and the produced composite becomes water absorbent again until it reaches crack saturation. Differential shrinkage of cement-mortars naturally provokes micro-cracks as shown in Attiogb   and Darwin's (1987: 491-500) study on submicrocracking in cement pastes and mortars. During the further maturing of the cement-mortar-plastic composite, from 24 hours to 28 days, combined shrinkages can also

take place due to the incorporation of melted waste plastic bags into the cement-mortar. This may explain the recorded difference in water absorption ratio increases beyond 12% of plastic content.

3.4 Effects of aggregates coating on mass and density of composite

This section analyses the results from measurements aimed at monitoring the evolution of the tested specimen's mass and absolute density, as a function of incorporated amounts of waste plastic bags. Figure 10.1 displays the recorded masses for the cement-mortar specimens, using the three variants of sand aggregates discussed earlier. In examining these data, it can be noted that the weight of cement-mortar specimens made with normalised sand is superior to that made with uncoated sand S_2 (control). The latter weighed significantly more than the manufactured cement-mortar specimens made with coated sand aggregates S_2 at a 10% molten waste plastic bags ratio. In other words, this clearly shows that the sand-aggregates coating process, using melted plastic bags, causes a mass reduction in cement-mortar specimens of identical dimensions. Such recorded tendency was realistic and coherent, due to replacing a mass portion of sand granules with molten plastic bags in unaltered mould volume that remains the same as for built cement-mortar specimens. Figure 10.2 displays the results from tests studying the average absolute density evolution of manufactured cement-mortar specimens using coated sand aggregates S_2 , at different percentages of added waste plastic bags during a 28-days observation. From these results, it can be concluded that, as the plastic bags ratio increased in cement-mortar composites, the absolute density of the specimen decreased. This seemed normal, as the specimen's volume was kept identical at $40 \times 40 \times 160 \text{mm}^3$, regardless of its molten plastic bags content, on the one hand, and the fact that the density of plastic bags is lower ($0.91\text{--}0.94 \text{g/cm}^3$) than that of the replaced sand (2.64g/cm^3), on the other.

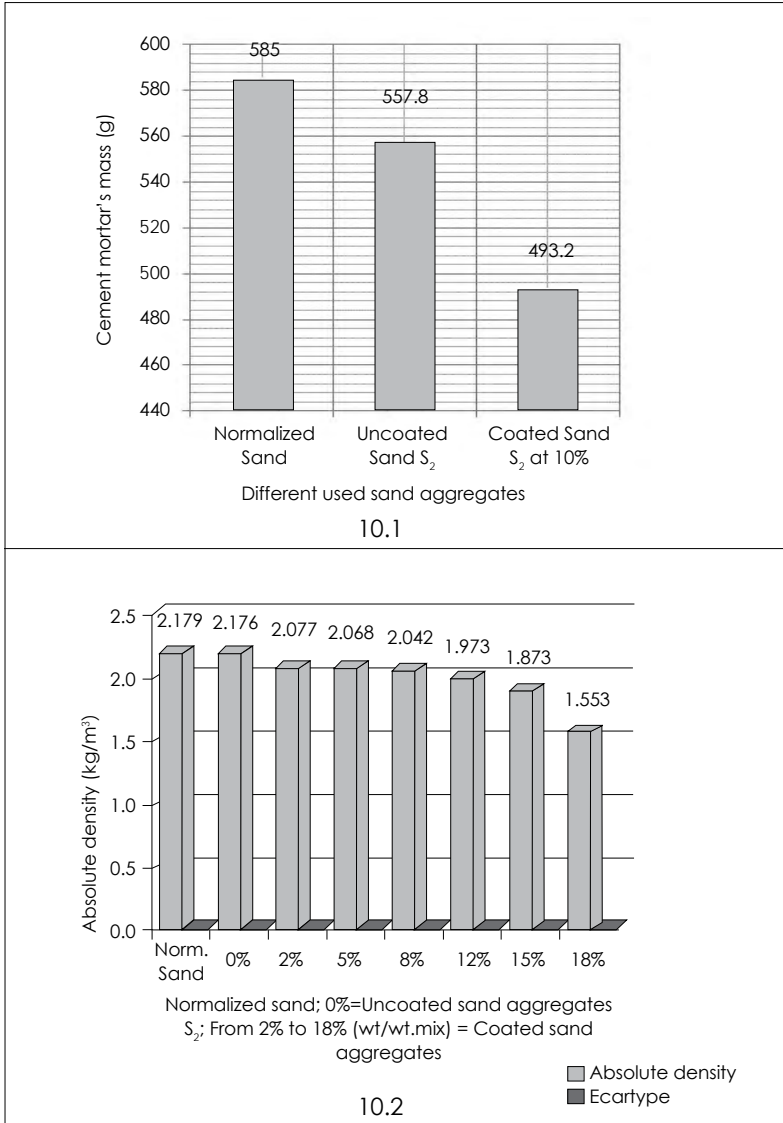

Figure 10: Compared masses (top) and absolute densities (bottom) for produced cement-mortars using three (3) sand variants: normalised sand, uncoated sand S_2 , and coated sand S_2 , at 10% plastic bags ratio

The polynomial model, that adequately fits these data obtained on the evolution of the composite specimen's absolute density (Y) with respect to molten waste plastic bags content (X), can be expressed by means of the function drawn from the tendency equation:

$$Y = -0.001 \cdot X^4 + 0.022 \cdot X^3 - 0.081 \cdot X^2 + 0.055 \cdot X + 2.164 \quad (5)$$

with a regression coefficient value of $R^2=0.998$.

This function remains roughly identical for the results obtained on specimens of 2-days and 7-days age, as well as for those of 28-days age tested ones.

3.5 Ripening effects on optimised composite mortar

Following the analysis of the data presented in the graphs for the behaviour of tested specimens made with coated sand aggregates, it was found that lower values in the water absorption ratio were obtained in contents ranging between 8% and 12%.

Table 3: Operative conditions for hydrothermal ripening cement-plastic mortars

<i>Ripening steps</i>	<i>Oven-drying temperature (°C)</i>	<i>Staying time (h)</i>	<i>Water-immersion temperature (°C)</i>	<i>Staying time (h)</i>
Step 1	105	72	21±1	72
Step 2	105	72	21±1	72
Step 3	150	72	21±1	72

In an optimisation progression, on the one hand, and observing the propensity reached from the experiments for studying water absorption ratio, on the other, it seemed essential to explore in more detail the case of an optimal coating ratio of 10% and then find any practical conditions under which to obtain better favourable to less water-absorption ratio scores. Table 3 summarises the hydrothermal ripening stages and corresponding operative conditions applied to cement-mortar composite specimens in these test series, which were also conducted to determine water absorption ratios. Figure 11 shows the different results obtained regarding the recorded water-absorption reduction ratio due to the hydrothermal ripening treatment applied to cement-plastic-mortar composite specimens.

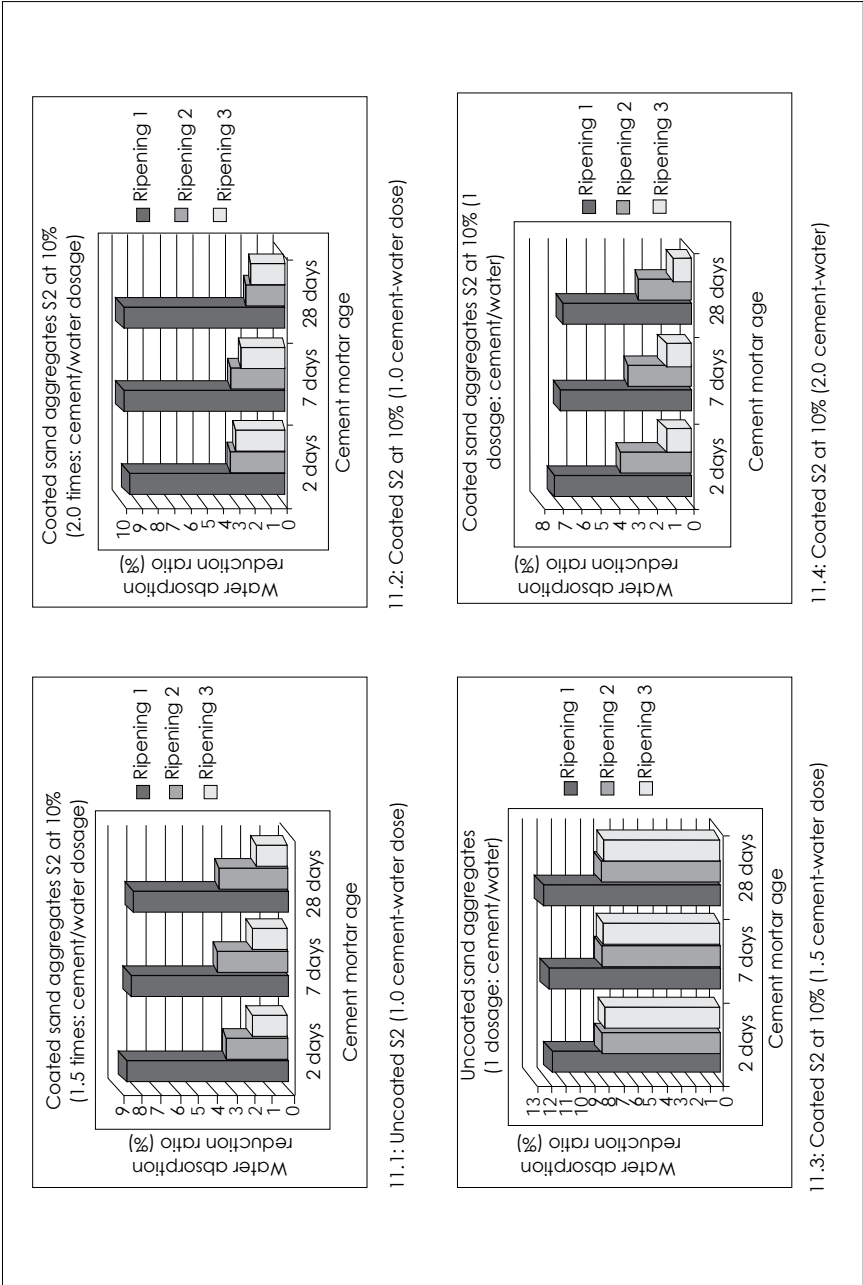

Figure 11: Measured water-absorption ratios showing a significant reduction for 10% waste plastic bags-coated cement-mortar composites

It is also important to note that variable dosages of cement and water have been experimented with: 1time, 1.5times and 2times cement-water dosages. The results for the cement-mortar specimens prepared with uncoated sand aggregates S_2 taken as control (Figure 11.1) showed that heat-maturing treatment induced some relatively weak effects on the behaviour of corresponding cement-mortars. Furthermore, values of water-absorption ratios were nearly constant for each of the three explored ages. Nevertheless, a very small difference (below 1%) in water-absorption ratios was noticed from 2-days to 28-days. It is suggested that the specimens' age does not significantly affect the water-absorption ratio of cement-plastic-mortar composites made of uncoated sand aggregates. This conclusion does not hold when compared with the results in Figures 11.2, 11.3 and 11.4. From the latter, the application of molten plastic bags coating has been clearly indexed as a determining factor that provokes differences in water-absorption ratios recorded in the test series. Indeed, the results in Figure 11.2 clearly show that the application of plastic-bags coating to S_2 sand aggregates, at 10% (wt/wt.mix basis), has contributed to a significant reduction in the water-absorption ratio for cement-mortar composite specimens. Moreover, the reduced water-absorption ratio was also affected, to a relatively higher extent, by heat-ripening treatment applied to cement-mortar composites. A similar result was also obtained when cement-water dosage was multiplied by 1.5 (Figure 11.3) and 2.0 (Figure 11.4), respectively. One could notice the slight effects of reduced water-absorption ratios in addition to those previously recorded, when the age of the cement-mortar composites increased, especially as maturing treatment conditions rose (ripening 3 at 150°C against ripening 2 or 1 at 105°C).

Ultimately, the results of these tests to evaluate the water-absorption ratio for the various cement-mortar specimens show that:

- an over-dosage of water and/or cement, in multiplying by 1.5 or 2 times, is not conducive to improving the water-absorption reduction ratio, by embedding waste plastic bags in cement-mortar composite by means of this chosen sand aggregates coating;
- a layer of molten waste plastic bags coating on sand aggregates significantly contributes to a reduction in the water-absorption ratio of cement-plastic-mortars. Indeed, sand-aggregates coating, to a large extent, reduces the water-absorption ratio from 10% to about 1% (exactly 0.923%), subsequently generating an improved reduction ratio of 85-90%.

Such interesting results have led us to confirm that the applied coats (molten waste plastic bags) successfully generated growths, mainly during the 150 C ripening stage, that act efficiently as obstructors for major porous sites in the structure of cement-plastic-mortars, drastically reducing the water penetration ratio of the resulting composites. It is known that these used waste plastic bags belonging to the thermoplastic polymers category are susceptible to relative deformation under heat (Dorlot *et al.*, 1986: 1-467; Halary, 2006: 1-73; Naskara & Chakia, 2010: 128-134; Vasudevan *et al.*, 2007: 105-111). Such behaviour also justifies the adopted specific coating process in the current investigation and, accordingly, in other chosen methods elsewhere (Vasudevan *et al.*, 2007: 105-111; Prasad *et al.*, 2009: 1-12; Yazoghli-Marzouk *et al.*, 2005: CD-ROM).

The performances of this process, for waste plastic bags valorization, were compared with those for prepared cement-mortars using classical Sikalite. In the latter, the prescription of EN-196.1 standards is 1kg of Sikalite for 50kg of cement. Figure 12 shows the results of a comparative study for water-absorption ratios of both variants of cement-mortar composites prepared by using the waste plastic bags and Sikalite, respectively.

The behaviour of the water-absorption ratio was also observed as a function of the specimen's age: at 2days, 7days and 28days. From these results, one can affirm that, for these three specimens, the water-absorption ratio of cement-mortar blended with melted waste plastic bags, through a process of aggregates coating, is chiefly lower than that made with classically applied Sikalite. As for Sikalite, the water-absorption ratio of prepared cement-plastic-mortar composites decreases as the specimen's age increases. Cement-mortar composites, blended with waste plastic bags, can qualitatively be successfully used as sealer materials instead of Sikalite in infrastructures construction. This result is very interesting and satisfactory in research on counteracting water penetration of cement-mortar built materials: the case of cement-mortar water repellents. However, there are significant disadvantages in the mechanical properties of these cement-mortar composites.

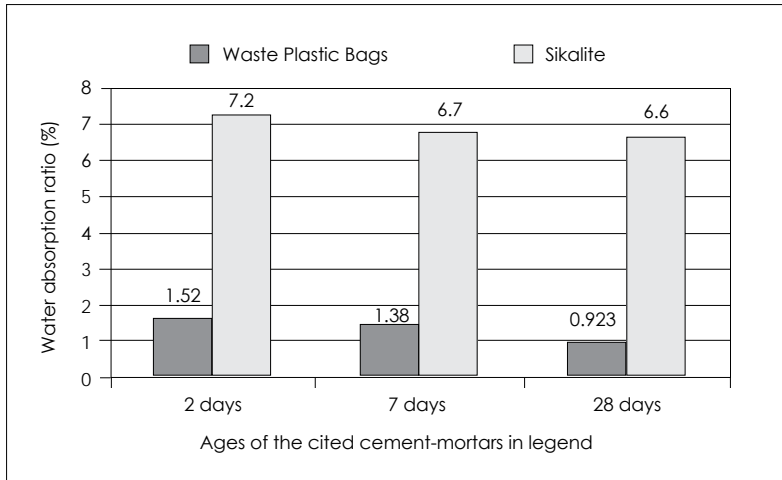
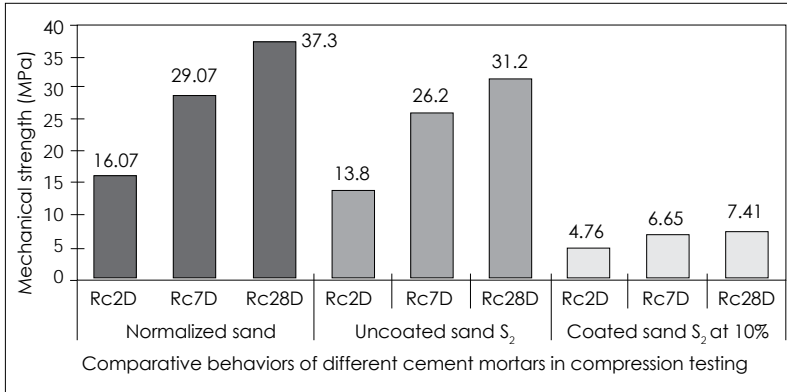

Figure 12: Compared values for water-absorption ratios of cement-mortar composites, using waste plastic bags (WP-Bags) and classical Sikalite

3.5 Measured mechanical resistances

Figure 13 shows the results from the mechanical tests done in 3-points bending (Figure 13.1) and classical compression (Figure 13.2), for the three (3) variants of sand aggregates (normalised, uncoated and coated sands). These sands are for specimens of cement-mortars made of normalised standard sand; those made of sand aggregates S_2 without plastic bags, and those made of cement-mortar-plastic composite with coated S_2 aggregates, using the optimised value of melted waste plastic bags content: 10% (wt/wt.mix). These data integrate the mechanical characteristics measured as a function of the specimen's age: 2days, 7days and 28days. Figure 13.1 presents the mechanical results of 3-points flexural bending on cement-mortars obtained from using the three (3) sand variants. One must bear in mind that the data of 3-points flexural bending of cement-mortar from normalised standard sand shows increased behaviour: from 4.08 ± 0.64 MPa at 2days, to 6.61 ± 0.63 MPa at 7days, up to 7.59 ± 0.73 MPa at 28days. The recorded values for flexural resistance are found to be consistent with those from standardised sand. Furthermore, it was observed that they are of the same order of magnitude as those obtained for cement-mortars prepared from uncoated control sand S_2 : 4.08 ± 0.64 MPa to 7.9 ± 0.17 MPa. The previous two sets of values are significantly higher than the resistances recorded for cement-mortar specimens prepared from coated sand aggregates S_2 , using

molten waste plastic bags at an optimized content of 10%: between 1.78 ± 0.51 MPa and 4.76 ± 0.24 MPa. Like the behaviour observed for values of standardized sand cement-mortar flexural strength, the values provided by the two sands S_2 studied cement-mortar variants (uncoated sand S_2 and molten plastic bags coated sand S_2) also developed a similar increase in tendency function of the specimen's age between 0 and 28 days.



13.1: Axial compression testing

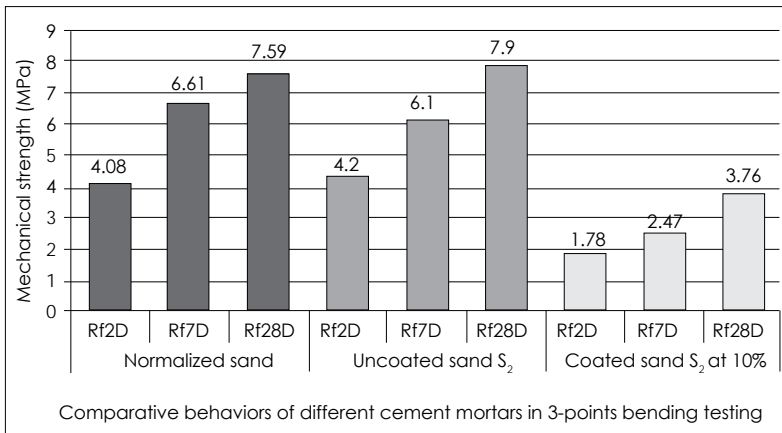

13.2: 3-points flexural bending tests

Figure 13: Comparison of mechanical strengths of cement-mortars of 3 sand aggregates: standardised, uncoated S_2 and coated S_2 at 10% waste plastic bags content

Legend: Notations R_{B2D} , R_{B7D} to R_{B28D} and R_{C2D} , R_{C7D} , R_{C28D} in the figures are identifiers of the values obtained for resistance in flexural bending (R_B) and in compression (R_C) for the tested cement-mortar specimens at 2 days, 7 days and 28 days.

Figure 13.2 shows the results of the compression testing of cement mortars made of three (3) sand variants, thus indicating that the compressive strength values of the standardised sand's mortar increased from 16.07 ± 1.04 MPa at 2 days, to 29.07 ± 0.63 MPa at 7 days and to 37.3 ± 0.28 MPa at 28 days. A similar trend was also recorded for cement-mortars prepared by using control sand S_2 and coated sand S_2 at 10% waste plastic bags content. However, one can observe that the resistance values displayed by control sand S_2 (uncoated cement mortar) are commonly lower than those of normalised standard sand: 13.8 ± 0.54 MPa, 26.2 ± 1.01 MPa, and 31.2 ± 0.81 MPa, respectively. These results are fairly consistent, since normalised standard sand is used because of its recognised high-quality properties. Values obtained from compressive testing the manufactured cement-mortar specimens using coated sand aggregates S_2 at 10% content are weak, namely 4.76 ± 0.24 MPa at 2 days, 6.65 ± 0.43 MPa at 7 days, and 7.41 ± 0.91 MPa at 28 days, respectively, compared to those from uncoated sand S_2 .

Table 4 presents the strength-reduction ratios calculated for cement-mortars, following the incorporation of waste plastic bags at optimised 10% (wt/wt.mix) content.

Table 4: Recorded behaviour for strength-reduction ratios of cement-mortars with coating of sand aggregates S_2 , using molten plastic bags at 10% content

<i>Evolution of strength-reduction ratio as function of the cement-mortar age (%)</i>			
Test types	2days	7days	28days
3-points bending	42.38	40.49	47.59
Compression	34.49	25.38	23.75

The values presented in Table 4 led to the conclusion that the inclusion of waste plastic bags with sand aggregates coating at an optimised ratio of 10% (wt/wt.mix) weakens the strength of decouplant cement-mortar composites, in ratios ranging between 40% and 48% for 3-points flexural bending and 24% and 35% for compression testing.

Figure 14 shows results for mechanical measurements in long-term (up to 90 days). These data clearly show that the resistance values

recorded for plastic bags incorporated in cement-mortars increased to 45 days, whereafter stabilisation finally occurred at average values of 8.83 ± 0.34 MPa in compression and 4.1 ± 0.82 MPa in 3-points flexural bending tests, respectively. This long-term increase in mechanical strength of the cement-plastic-mortar composite has already been observed in results for classical cement concretes (Larbi, 1993: 1-69; Maso, 1982: 247-259; Neville, 2000: 463-513; Wood, 1991: 630-643; Pumia *et al.*, 2003: 134-140).

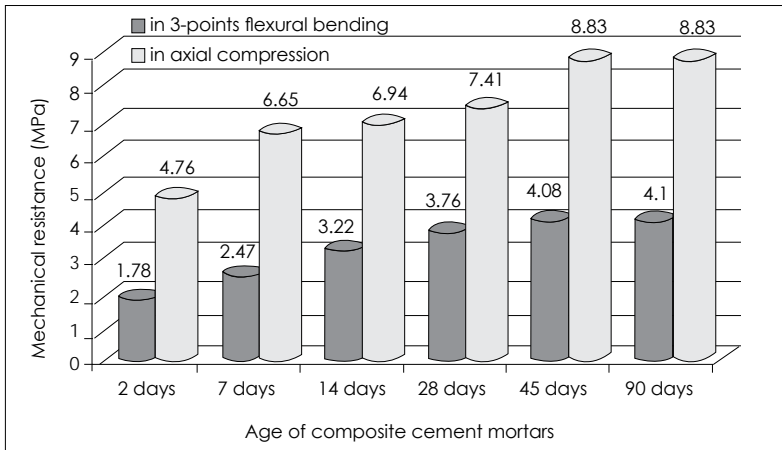

Figure 14: Strength in 3-points bending and compression for cement-mortar specimens using coated sand aggregate S_2 at 10% plastic bags versus mortars age 2 to 90 days

This shows that the incorporation of melted waste plastic bags in cement-mortar composites does not affect their long-term storage maturing. All the values obtained for mechanical resistance of the cement-plastic-mortar composites are understandably weak compared to those from simple uncoated sand aggregates S_2 cement-mortars (Larbi, 1993: 1-69; Neville, 2000: 463-513; Wood, 1991: 630-643; Pumia *et al.*, 2003: 134-140).

For that reason, these low-resistance values (8.83 MPa in compression and 4.1 MPa in 3-points flexural bending) clearly define and restrict the intended uses of cement-plastic-mortar composites containing 10% incorporated plastic bags compared to the ones for outside layers, as plasters for walls, or surfaces finishing of infrastructural buildings, or roads construction.

3.6 Potential use of cement-mortar-plastic composites

Table 5 presents the results from a comparative study devoted to the potential uses of the fused plastic-cement-mortar composites in the form of quarry tiles for walls and soil coating. These data were linked to water-absorption ratio and surface wear-resistance-index for classical commercial quarry tiles of different types.

Table 5: Measured water-absorption ratios, surface-wear depths and WRI for commercial quarry tiles (three kinds) and plastic-cement-mortar composites

<i>Tested materials types</i>	<i>Water absorption rate (%)</i>	<i>Wear depth at 75 rotation (L mm)</i>	<i>Wear-Resistance-Index (WRI)</i>
Stoneware tiles	0.89±0.31 (20*)	21.60±1.35 (20*)	915-1405
Fine ceramic	14.95±5.44 (20*)	23.00±1.63 (20*)	725-1240
Artisanal mortar tiles	13.34±2.64 (10**)	40.20±4.32 (10**)	120-240
Cement-mortar-plastic	0.90±0.05 (12***)	26.30±1.53 (12***)	510-725

* on 20 trials basis

** on 10 trials basis

*** on 12 trials basis

The wear depth (L) takes value in an interval of $15\text{mm} \leq L \leq 54\text{mm}$, corresponding to 3360 (at $L=15\text{mm}$) $\geq \text{WRI} \geq 70$ (at $L=54\text{mm}$). The more the L -value approaches 15mm , the more resistant the tested material. An analysis of the results in Table 5 shows that the recorded wear depth L (**$26.30 \pm 1.53\text{mm}$**) corresponds to the wear-resistance-index value (WRI) of **$510-725$** . This is relatively lower than those for imported commercial products such as porcelain tiles $915-1405$ ($21.60 \pm 1.35\text{mm}$) and faïences/fine ceramic $725-1240$ ($23 \pm 1.63\text{mm}$), but higher than locally artisanal fabricated products $120-240$ ($40.20 \pm 4.32\text{mm}$).

Figure 15 shows examples of traditional buildings made of local lateritic sand, the basic raw building material used in Beninese villages and neighbouring countries. Indeed, according to a report of the third general population census and housing (RGPH), 55.3% of siding walls, 1.1% of roof sand 40.2% of soils are made of earthen bars, and 55.8% of cement screed (INSAE, 2013: 1-8). These needs illustrate that surface-coating material can undoubtedly serve the interests of the majority of the population. In fact, without a great financial constraint, it would solve two problems: seal concrete and mortar slabs, on the one hand, and integrate bathrooms inside traditional buildings made of earthen bar walls, on the other.



Figure 15: Traditional earthen buildings deterioration due to water penetration showing the urgent need for wall coatings in Benin

Conclusion

The two most important objectives of this article were to analyse the water-absorption ratio and decouplant mechanical strength of cement-mortars blended with molten waste plastic bags, by means of a sand aggregates coating method. The results have shown that and aggregates coating for construction processes is feasible, thus providing the possibility for waste plastic bags recycling and subsequently confirming waste plastic bags valorisation. Various tests have revealed that, at waste plastic bags ratios of between 5% and 18% (wt/wt.mix), sand aggregates coating is beneficial for the mortars in order to counteract water penetration, for which a reduction ratio of almost 85%-90% was recorded at 10 % (wt/wt.mix) inclusion level. In return, significant weakening effects were recorded on the cement-mortar's mechanical strength, both in compression and in 3-points flexural bending tests, although the strength values thus obtained showed a gradual increase with mortar's age. Loss of strength, compared to baseline, was approximately 1/3 in compression and 1/2 in 3-points flexural bending at the specimen's age of 28 days.

The overall results led to the conclusion that cement-mortars made of molten plastic bags coated with sand aggregates cannot be used in structural constructions. Nevertheless, this composite material can be used effectively for surface coating works in building processes.

References list

- Adégbindin, S. 2009. Caractérisation des déchets solides ménagers (DSM) dans la commune d'Abomey-Calavi. Mémoire de diplôme d'Ingénieur de conception. Ecole Polytechnique d'Abomey-Calavi. Université d'Abomey - Calavi, Bénin.
- Afroz-Sultana, S.K & Prasad, K.S.B. 2012. Utilization of waste plastics as a strength modifier in surface course of flexible and rigid pavements. *International Journal of Engineering Research and Applications*, 2(4), pp. 1185-1191.
- Al-Hadidy, A.I & Tan, Y-Q. 2009. Effect of polyethylene on life of flexible pavements. *Construction and Building Materials*, 23, pp. 1456-1464.
- ASTM-C1403-15. 2015. *Standard test method for rate of water absorption of masonry mortars*. 5p (Published on 07-01-2015). [online] Available from: <www.astm.org> [Accessed: 12 March 2015].
- Attiogbé, E.K. & Darwin, D. 1987. Submicrocracking in cement paste and mortar. *ACI Materials Journal*, 84(6), pp. 491-500.
- Behjat, Y., Cheng, J., Polak, M. & Penlidis, A. 2014. Effect of molecular structure on the short-term and long-term mechanical behaviour of high-density polyethylene. *Journal of Materials in Civil Engineering*, 26(5), pp. 795-802.
- Codjia, R.P. 2000. La prolifération des déchets plastiques à Cotonou: Effet sur la santé et sur le développement durable. Mémoire Diplôme d'Etudes Approfondies. (DEA). Faculté des Lettres Arts et Sciences Humaines FLASH). Université Nationale du Bénin. Abomey-Calavi.
- Dorlot, J-M., Bailon, J-P. & Masounave, J. 1986. *Des matériaux*. 2ème ed. Ecole Polytechnique de Montréal.
- Garcia-Morales, M.P., Partal, F.J. & Navarro, C.G. 2006. Effect of waste polymer addition on the rheology of modified bitumen. *Fuel*, 85(7-8), pp 936-943.
- Gbèdo, V. 2009. *Problématique de la valorisation des déchets plastiques à Cotonou*. Thèse de Doctorat, Faculté des Lettres, Arts et Sciences Humaines (FLASH). Université d'Abomey-Calavi, Bénin.
- Ghernouti, Y. & Rabehi, B. 2009. Récupération et valorisation des déchets de sacs en plastique dans le domaine de construction. In: *Proceedings of the 1st International Conference on Sustainable Built Environment Infrastructures in Developing Countries*. ENSET Oran (Algeria), 12-14 Octobre, pp. 93-100.

- GTZ & MEHU. 1998. Le cycle du plastique au Bénin. In: Rapport de Journée de Réflexion. Cotonou, Bénin. 09 Décembre: 27p.
- Gupta, S. & Veeraragavan, A. 2009. Fatigue behaviour of polymer modified bituminous concrete mixtures. *Journal of the Indian Roads Congress*, 568, pp. 55-64.
- Halary, J.L. 2006. *Eléments de compréhension moléculaire de la déformation des matériaux polymères*. In: De la macromolécule au matériau polymère. J.L.Halary et F. Lauprêtre Edition, Belin. Collection Echelles, Paris (France).
- INSAE. 2013. *Résultats du recensement général de la population et de l'habitation (RGPH3)*. Institut National de la Statistique et de l'Analyse Economique (INSAE), Ministère du Développement, de l'Analyse Economique et de la Prospective (MDAEP). Cotonou, Juin, 8p.
- Jain, P.K., Kumar, S. & Sengupta, J.B. 2011. Mitigation of rutting in bituminous roads by use of waste polymeric packaging materials. *Indian Journal of Engineering and Materials Science*, 18(3), pp. 233-238.
- Larbi, J.A. 1993. Microstructure of the interfacial zone around aggregate particles in concrete. *Heron*, 38(1), pp. 1-69.
- Lawson, V., Liady, N. & Boglo, G. 2008. *Valorisation des DSM au Benin: Atouts et limites*. In: Rapport d'étude DCAM-BETHESDA. Cotonou, 63p.
- Maso, J-C. 1982. Chapitre 14: La liaison pâte-granulats, pp. 247-259. In: *Le béton hydraulique*. Baron J. & Sauterey R., Editions Presses de l'Ecole Nationale des Ponts et Chaussées, Paris. 560p.
- Moatasim, A., Cheng, P.F. & Al-Hadidy, A. 2011. Laboratory evaluation of HMA with high-density polyethylene as a modifier. *Construction and Building Materials*, 25(5), pp. 2764-2770.
- Naskara, M.T.K & Chakia, K.S. 2010. Effect of waste plastic as modifier on thermal stability and degradation kinetics of bitumen/waste plastics blend. *Thermochimica Acta*, pp. 128-134.
- Neville, M.A. 2000. Chapitre 10: Durabilité du béton, pp. 463-513. In: *Propriétés des bétons*. Traduit par le Centre de Recherche Interuniversitaire sur le Béton (CRIB). Editions Eyrolles, Paris. 806p.
- Prasad, D.S.V, Prasada-Raju, G.V.R & Kumar, A. 2009. Utilization of industrial waste in flexible pavement construction. *Electronic Journal of Geotechnical Engineering (EJGE)*, 13(D), pp. 1-12.

Punmia, B.C, Jain, A.K & Jain, A.Kr. 2003. Chapter 6. Cement mortar, pp. 134-140. In: *Comprehensive basic civil engineering*. Firewall Media Editions, India. 446p.

RNCN, 2011. *Etude sur la gestion des déchets plastiques dans l'espace UEMOA: Cas du Bénin*. Rapport final du Réseau National des Centres de Ressources. Cotonou (Novembre). [online] Available from: <http://mncrbenin.org/IMG/pdf/Rapport_d_etudes_dechets_plastique_au_Benin-2.pdf>[Accessed: 12 March 2015].

Vasudevan, R., Nigam, S.K, Velkennedy, R., Sekari, A., Ramalinga, C. & Sundarakannan, B. 2007. Utilization of waste polymers for flexible pavement and easy disposal of waste polymers. In: *Proceedings of International Conference on Sustainable Solid Waste Management*. Chennai, India, 5-7 September, pp.105-111.

Vissoh, A.S. 2012. *Accès et occupation du sol dans les villes de Dassa-Zoumè et de Savalou: Une contribution à l'étude du foncier dans les villes secondaires du Bénin*. Thèse de Doctorat Unique en Géographie Urbaine. Université d'Abomey-Calavi.

Wood, S.L.1991. Evaluation of the long-term properties of concrete. *ACI Materials Journal*, 88(6), pp. 630-643.

Word-Bank. 2010. République du Bénin : Analyse Environnementale du Pays. Rapport Final- n°58190-BJ, Août, 87p.

Xie-Ping,J.,Beaudouin, J. & Brousseau, R. 1991. Effect of aggregate size on the transition zone properties at the Portland cement paste interface. *Cement and Concrete Research*, 21(6), pp. 999-1005.

Yazoghli-Marzouk, O., Dheilily, R.M. & Queneudec, M. 2005. Valorisation des déchets d'emballages plastiques dans les matériaux de construction. In: *Récents Progrès en Génie des Procédés*, no. 92. 10ème Congrès de la Société Française de Génie des Procédés (SFGP): Le génie des procédés vers de nouveaux espaces. Toulouse, 20-22 septembre 2005 (CD-ROM). France, Paris: Ed. Lavoisier, CD-ROM.